



Vowel Digraphs - Matching Sounds

ELA

Name _____ Class _____ Date _____

Different vowel digraphs can make the same vowel sound in different words.

Cut out the cards and complete the vowel digraphs. Then match cards that have the same vowel sound but different digraphs.

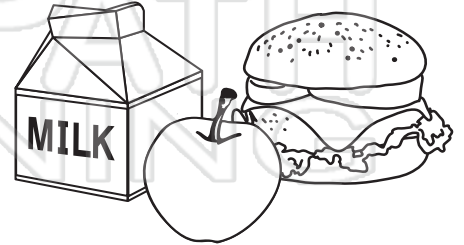
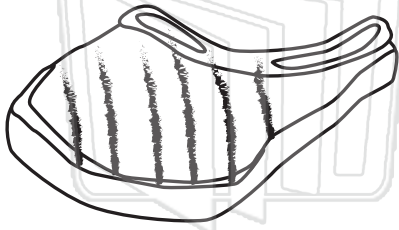

PREVIEW

Please [Sign In](#) or [Sign Up](#) to download the printable version of this worksheet



glu ____



che ____

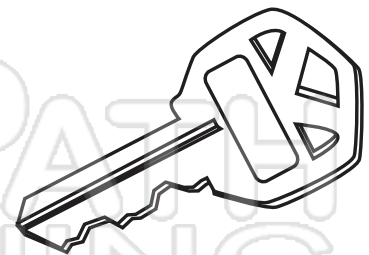

ke ____



Vowel Digraphs - Matching Sounds

ELA

Name _____ Class _____ Date _____

Different vowel digraphs can make the same vowel sound in different words.

Cut out the cards and complete the vowel digraphs. Then match cards that have the same vowel sound but different digraphs.

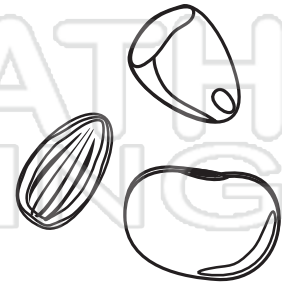
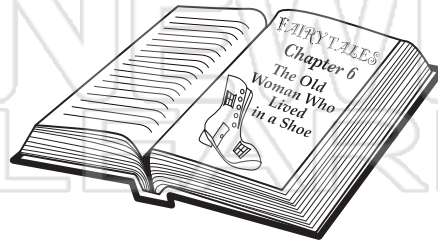
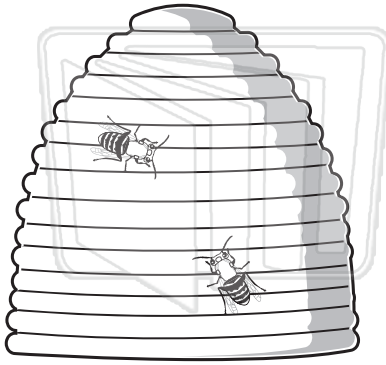

PREVIEW

Please [Sign In](#) or [Sign Up](#) to download the printable version of this worksheet



cha__r



flo__r

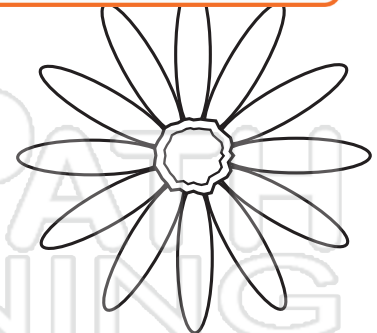

flo__er



Vowel Digraphs - Matching Sounds

ELA

Name _____ Class _____ Date _____

Different vowel digraphs can make the same vowel sound in different words.

Cut out the cards and complete the vowel digraphs. Then match cards that have the same vowel sound but different digraphs.

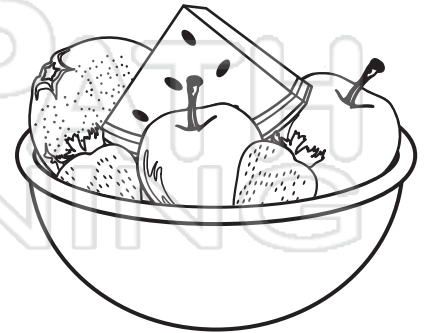
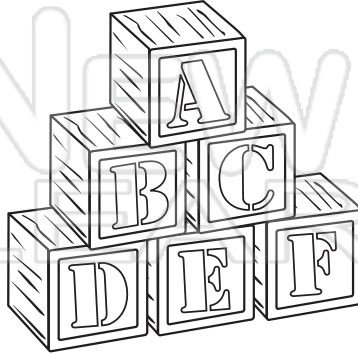
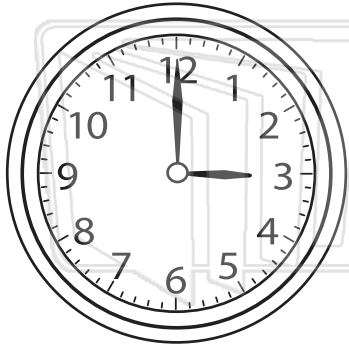

PREVIEW

Please [Sign In](#) or [Sign Up](#) to download the printable version of this worksheet



le _ f



be _ t

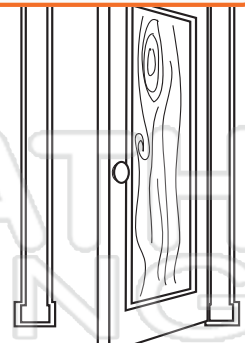

do _ r



Vowel Digraphs - Matching Sounds

ELA

Name _____ Class _____ Date _____

Different vowel digraphs can make the same vowel sound in different words.

Cut out the cards and complete the vowel digraphs. Then match cards that have the same vowel sound but different digraphs.

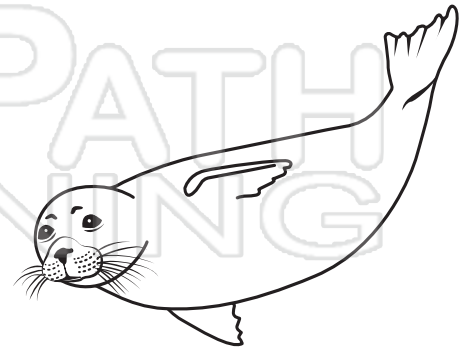
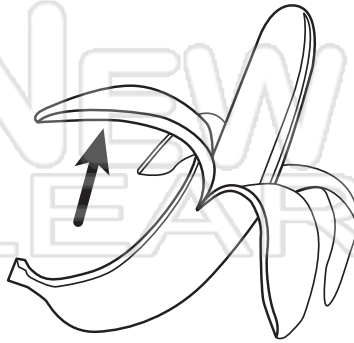

PREVIEW

Please [Sign In](#) or [Sign Up](#) to download the printable version of this worksheet



thro _____



to _____s

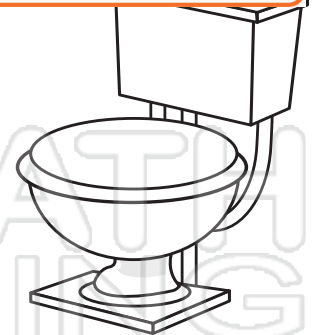

to _____let



Name _____ Class _____ Date _____

Different vowel digraphs can make the same vowel sound in different words.

Cut out the cards and complete the vowel digraphs. Then match cards that have the same vowel sound but different digraphs.

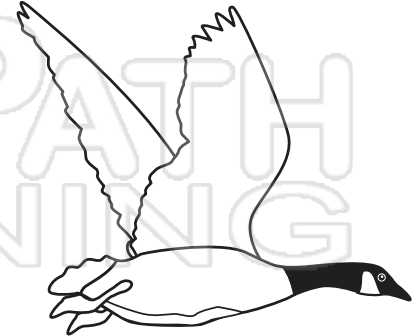
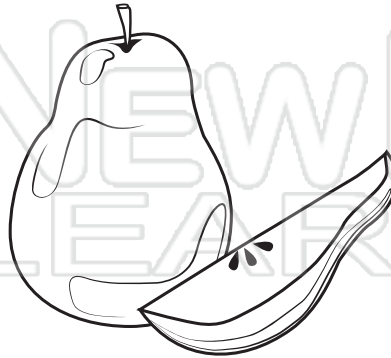
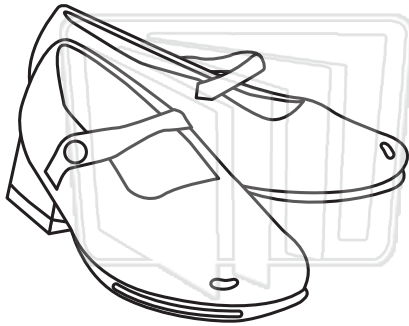

PREVIEW

Please [Sign In](#) or [Sign Up](#) to download the printable version of this worksheet

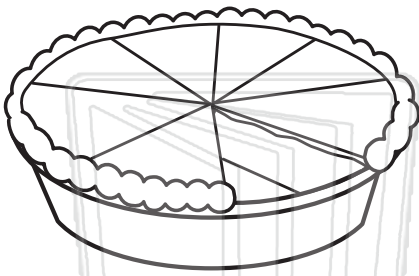

pi__



ra__n



d__y



Vowel Digraphs - Matching Sounds

ELA

Name _____ Class _____ Date _____

Different vowel digraphs can make the same vowel sound in different words.

Cut out the cards and complete the vowel digraphs. Then match cards that have the same vowel sound but different digraphs.

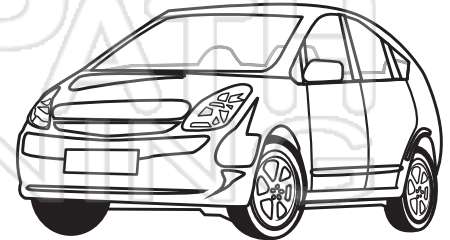
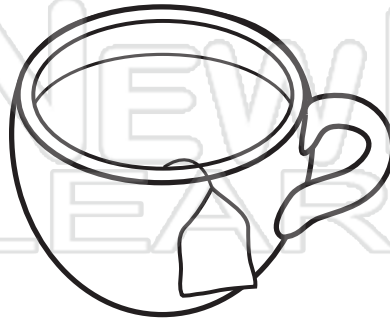

PREVIEW

Please [Sign In](#) or [Sign Up](#) to download the printable version of this worksheet

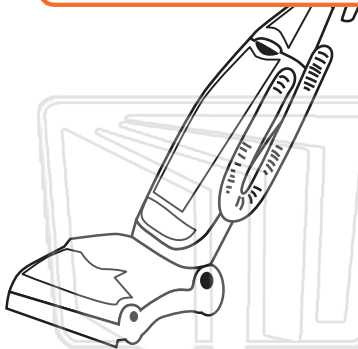

cle__n

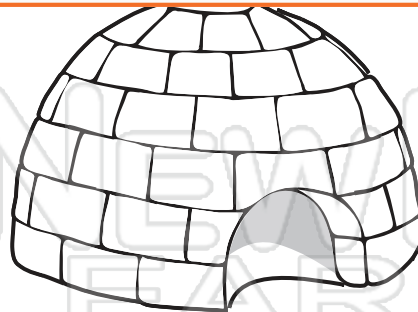

fre__ze



ha__r



Vowel Digraphs - Matching Sounds

ELA

Name _____ Class _____ Date _____

Different vowel digraphs can make the same vowel sound in different words.

Cut out the cards and complete the vowel digraphs. Then match cards that have the same vowel sound but different digraphs.

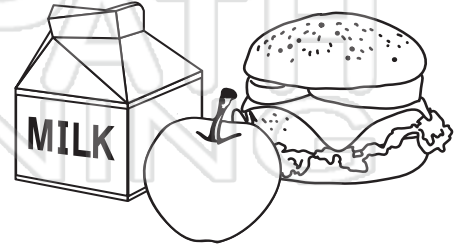
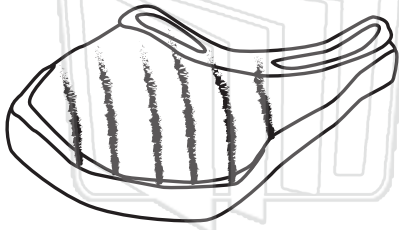

PREVIEW

Please [Sign In](#) or [Sign Up](#) to download the printable version of this worksheet



glue



chew

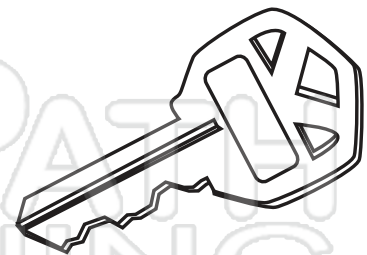

key



Name _____ Class _____ Date _____

Different vowel digraphs can make the same vowel sound in different words.

Cut out the cards and complete the vowel digraphs. Then match cards that have the same vowel sound but different digraphs.

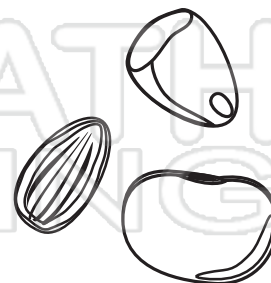
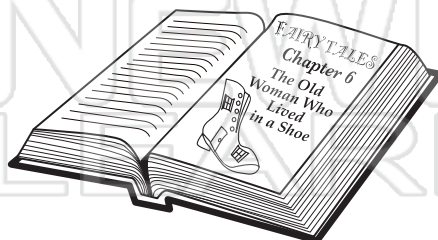
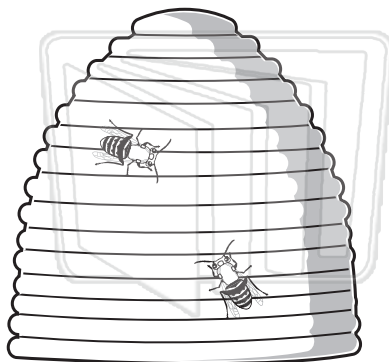

PREVIEW

Please [Sign In](#) or [Sign Up](#) to download the printable version of this worksheet



chair



flour

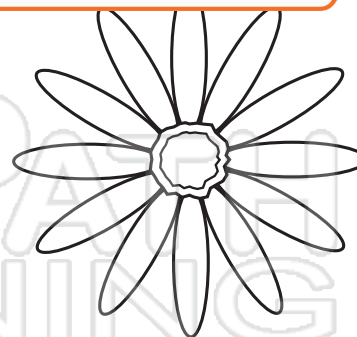

flower



Vowel Digraphs - Matching Sounds

ELA

Name _____ Class _____ Date _____

Different vowel digraphs can make the same vowel sound in different words.

Cut out the cards and complete the vowel digraphs. Then match cards that have the same vowel sound but different digraphs.

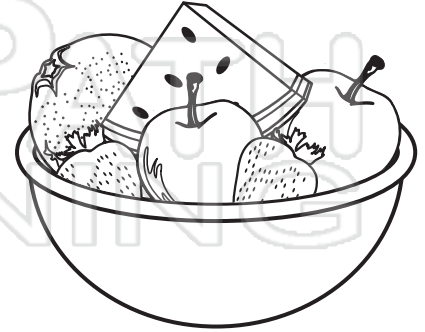
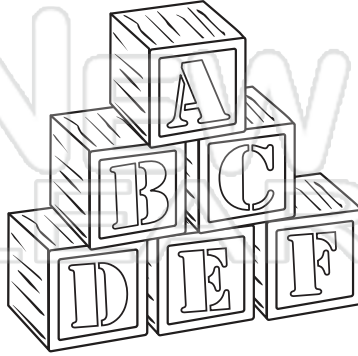
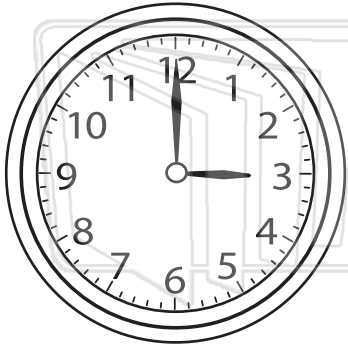

PREVIEW

Please [Sign In](#) or [Sign Up](#) to download the printable version of this worksheet



leaf



beet

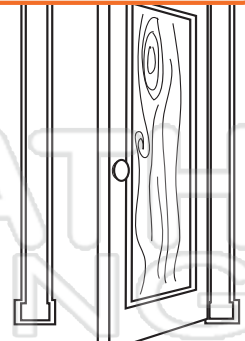

door



Name _____ Class _____ Date _____

Different vowel digraphs can make the same vowel sound in different words.

Cut out the cards and complete the vowel digraphs. Then match cards that have the same vowel sound but different digraphs.

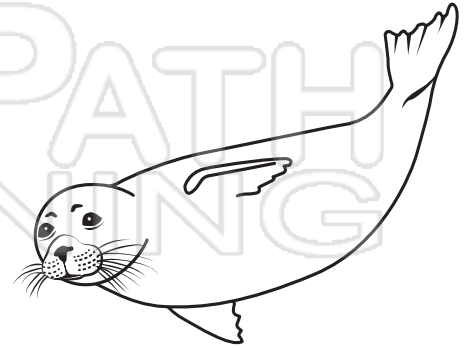
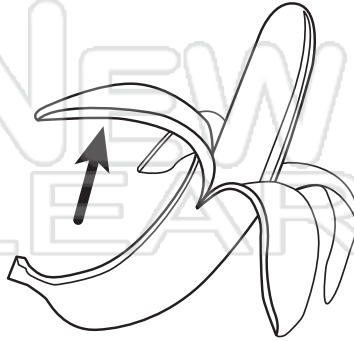

PREVIEW

Please [Sign In](#) or [Sign Up](#) to download the printable version of this worksheet



throw

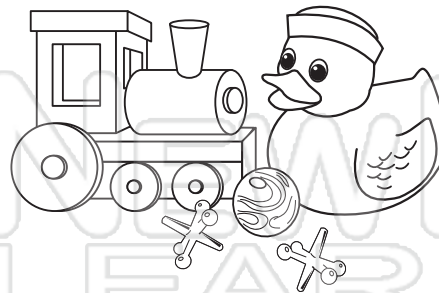

toys

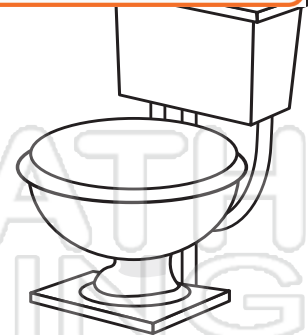

toilet



Name _____ Class _____ Date _____

Different vowel digraphs can make the same vowel sound in different words.

Cut out the cards and complete the vowel digraphs. Then match cards that have the same vowel sound but different digraphs.

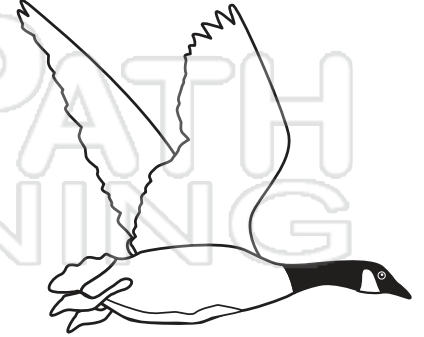
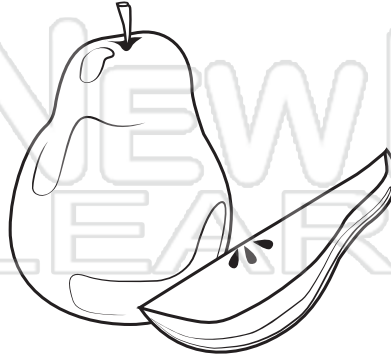
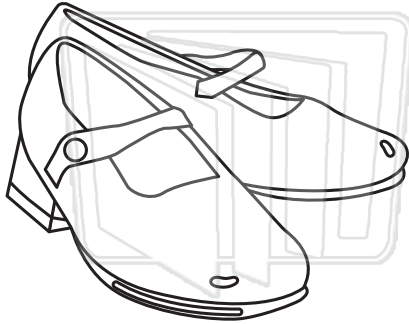

PREVIEW

Please [Sign In](#) or [Sign Up](#) to download the printable version of this worksheet

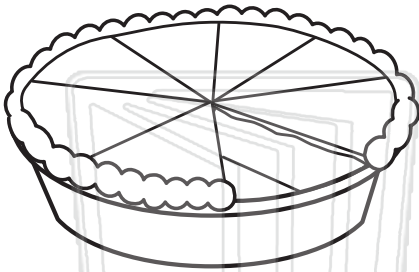

pie



rain



day



Name _____ Class _____ Date _____

Different vowel digraphs can make the same vowel sound in different words.

Cut out the cards and complete the vowel digraphs. Then match cards that have the same vowel sound but different digraphs.

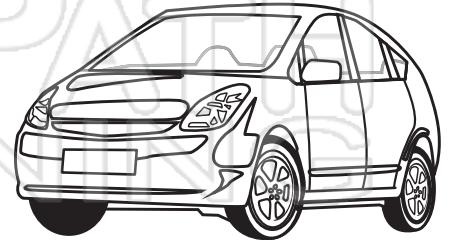

PREVIEW

Please [Sign In](#) or [Sign Up](#) to download the printable version of this worksheet

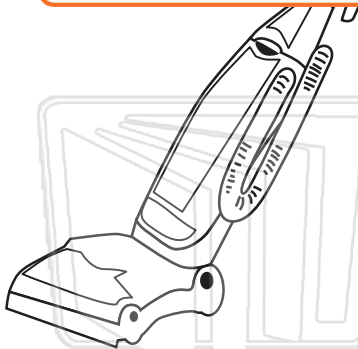

clean

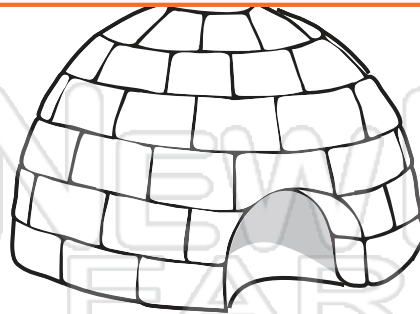

freeze



hair