

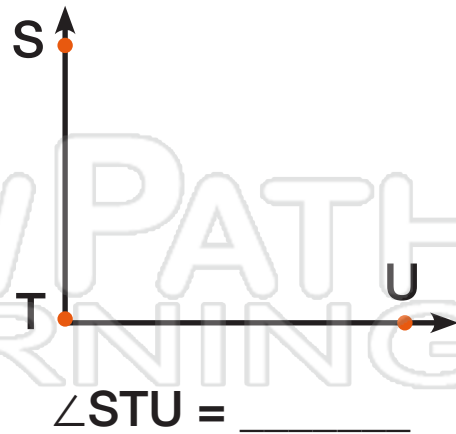

Name _____ Class _____ Date _____

Use a protractor to measure the angles. Label them acute, right or obtuse.

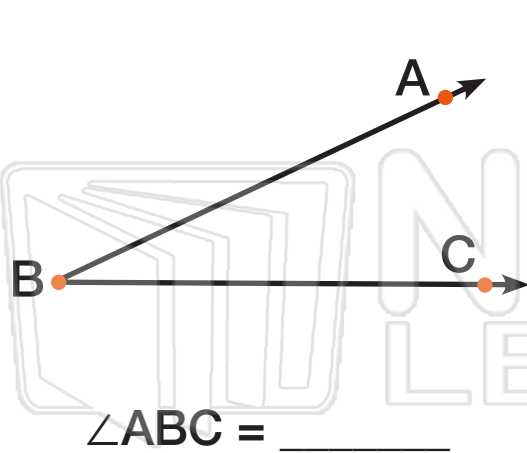

PREVIEW

Please [Sign In](#) or [Sign Up](#) to download the printable version of this worksheet

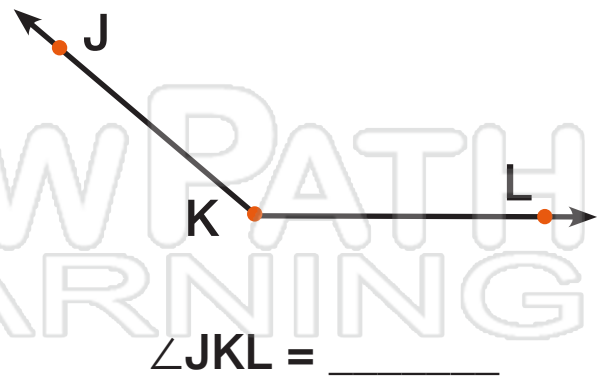
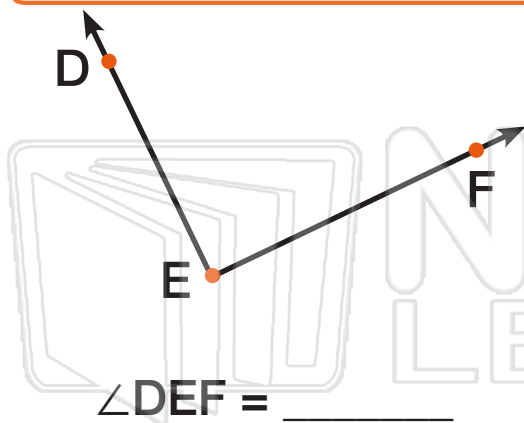



Name _____ Class _____ Date _____

Use a protractor to measure the angles. Label them acute, right or obtuse.

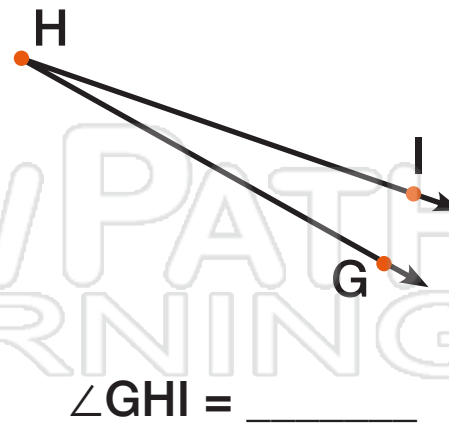
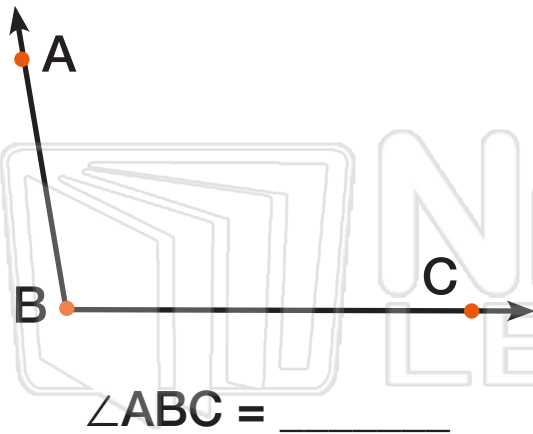

PREVIEW

Please [Sign In](#) or [Sign Up](#) to download the printable version of this worksheet

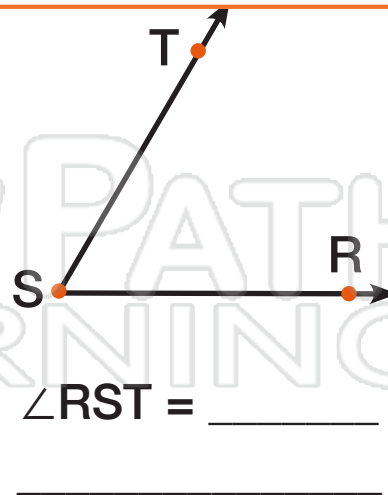
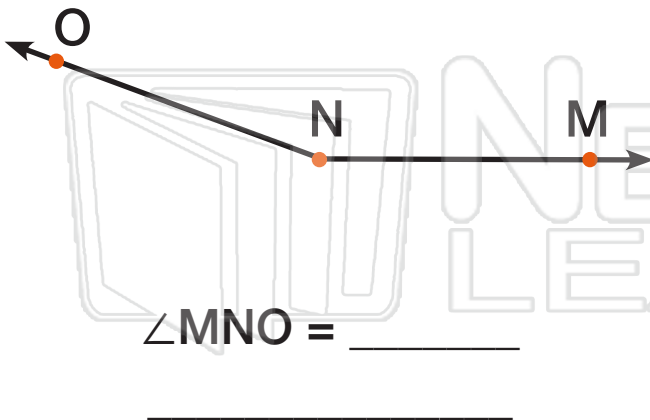



Name _____ Class _____ Date _____

Use a protractor to measure the angles. Label them acute, right or obtuse.

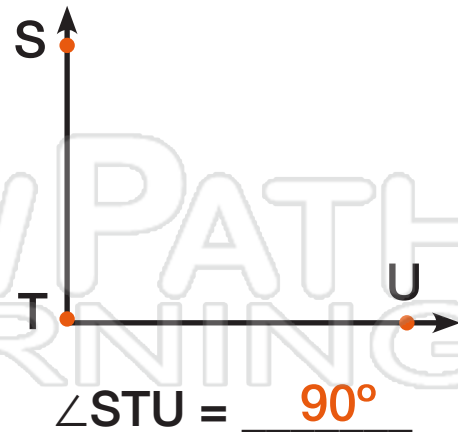
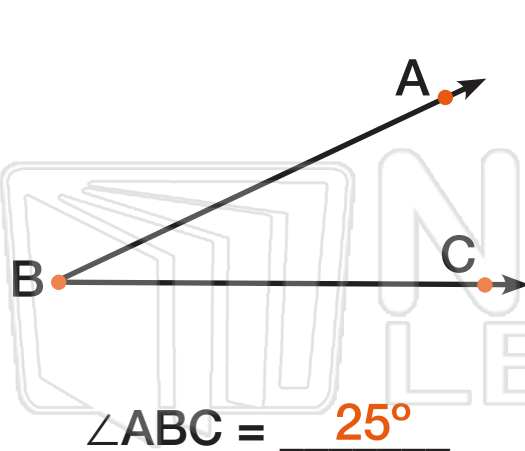

PREVIEW

Please [Sign In](#) or [Sign Up](#) to download the printable version of this worksheet

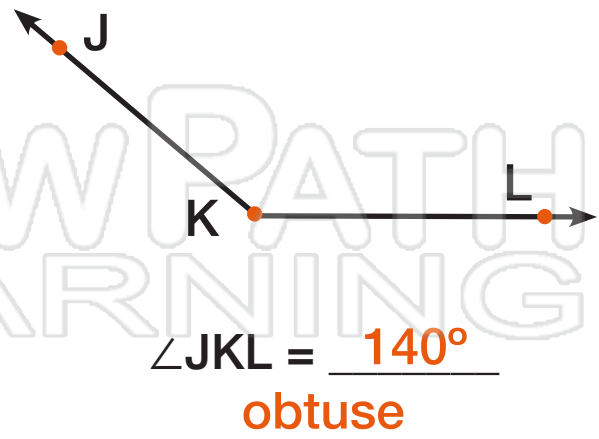
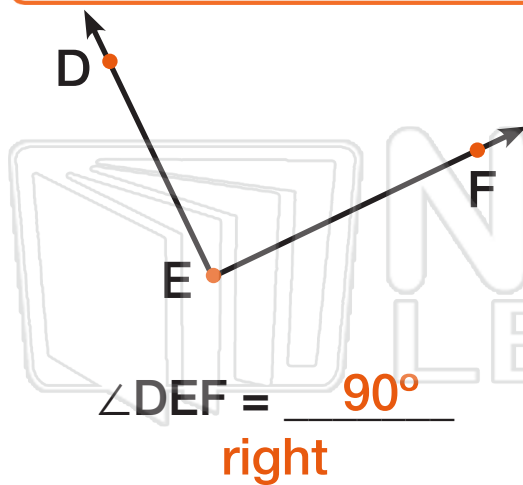



Name _____ Class _____ Date _____

Use a protractor to measure the angles. Label them acute, right or obtuse.

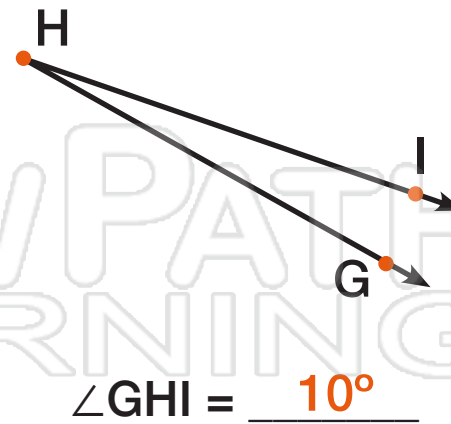
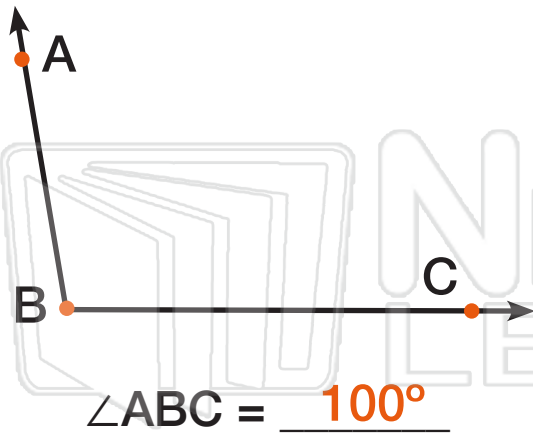

PREVIEW

Please [Sign In](#) or [Sign Up](#) to download the printable version of this worksheet

